

EV 227B (EVSR)

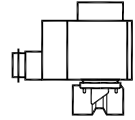

EV 227B 10

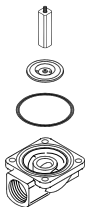
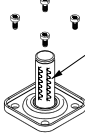
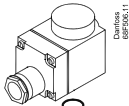
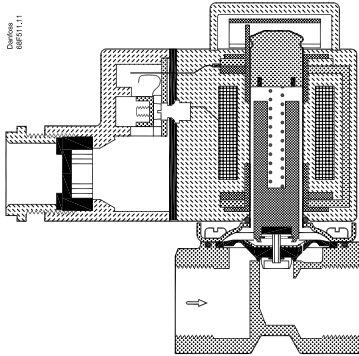

EV227B 10 B G38 /
E NC 000 /
032UXXXX / WWY /
made in XXXXXXXX

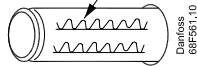

Danfoss
68F581.10

EV 227B 12-22

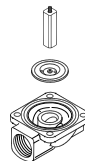
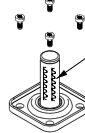
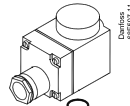
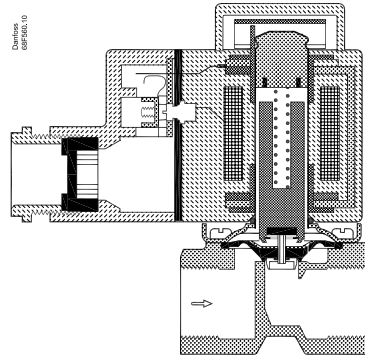

EV227B 22 G1 /
E NC 000 /
032UXXXX / WWY /
made in XXXXXXXX

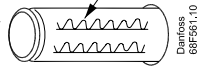

Danfoss
68F581.10

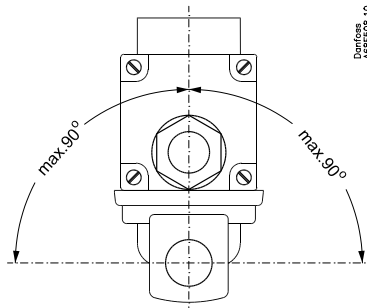

Danfoss
A6F5305.10

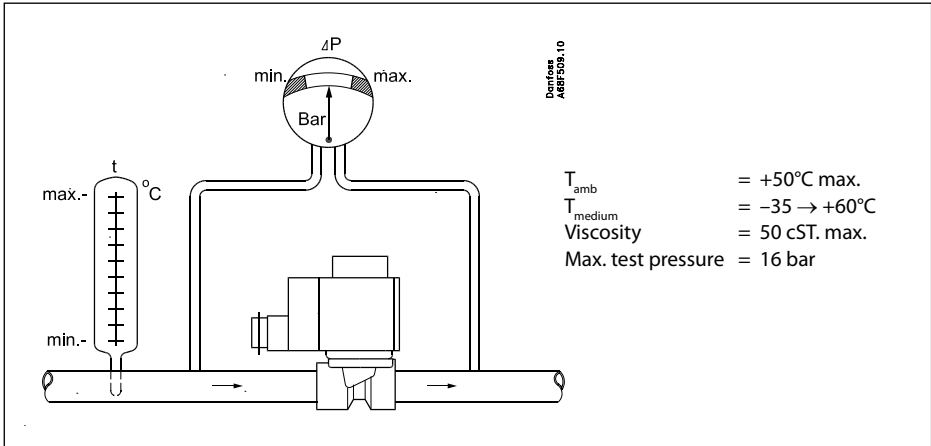

Danfoss
A8BF443.10

EV 227B	Nm	kpm	ft-lbs
10	1.4	0.14	1.0
12	2.8	0.28	2.0
14	2.8	0.28	2.0
18	4.5	0.45	3.2
22	4.5	0.45	3.2

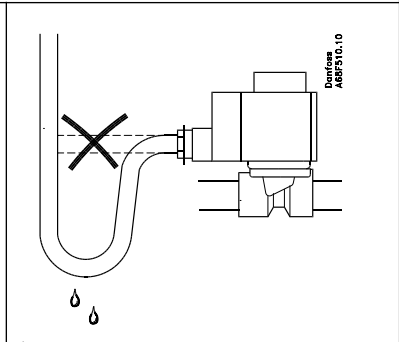

NC						
	10 W a.c.		12 W a.c.		20 W d.c.	
	min.	max.	min.	max.	min.	max.
EV 227B	0.1	5.0	0.1	5.0	0.1	5.0

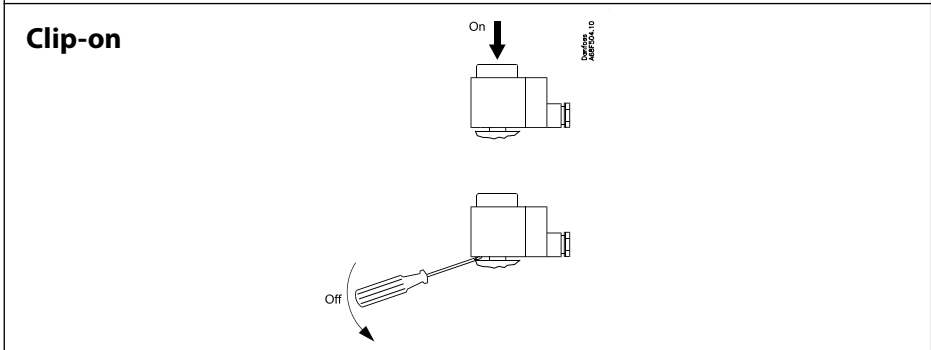

Danfoss can accept no responsibility for possible errors in catalogues, brochures and other printed material. Danfoss reserves the right to alter its products without notice. This also applies to products already on order provided that such alterations can be made without substantial changes being necessary in specifications already agreed. All trademarks in this material are property of the respective companies. Danfoss and the Danfoss logotype are trademarks of Danfoss A/S. All rights reserved.