

Switch Mode Power Supply

S8VK-S (60/120-W Models)

A Perfect Fit for Small Control Panels
Coated PCBs for Better Resistance to Environment
Easy Wiring by Push-in Plus Technology



- Operation possible at ambient temperatures from -40 to 70°C.
- DC input supported (90 to 350 VDC).
- Power Boost function at 120%.
- Horizontal side-by-side mounting.
- Vibration resistance to 5G, and 300-VAC abnormal input voltage supported for 1 second.
- Complies with EN/IEC 61558-2-16.
- UL 508 Listing/UL 1310 Class 2 output standards *1
- ANSI/ISA 12.12.01
- Certification for 3,000 m altitude (UL/EN/IEC 60950-1 and EN 50178).
- Lloyd's, DNV GL *2
- Conforms to SEMI F47-0706.
- RoHS compliant

*1. UL 1310 Class2 output (For 60W Only)

*2. Certification is pending for DNV GL.



⚠ Refer to *Safety Precautions for All Power Supplies and Safety Precautions* on page 11.

Model Number Structure

Model Number Legend

Note: Not all combinations are possible. Refer to *List of Models* in *Ordering Information*, below.

S8VK-S □□□□□□
 1 2

1. Power Ratings

060: 60 W

120: 120 W

2. Output voltage

24: 24 V

Ordering Information

Note: For details on normal stock models, contact your nearest OMRON representative.

Power ratings	Rated input voltage	Rated output voltage	Rated output current	Maximum boost current	Model number
60 W	100 to 240 VAC	24 V	2.5 A	3 A	S8VK-S06024
120 W	(allowable range: 85 to 264 VAC or 90 to 350 VDC)	24 V	5 A	6 A	S8VK-S12024

S8VK-S

Specifications

Ratings, Characteristics, and Functions

Item	Power rating Output voltage	60 W		120 W		
		24 V		24 V		
Efficiency	115 VAC input *1	87% typ.		90% typ.		
	230 VAC input *1	89% typ.		92% typ.		
Input	Voltage range *2	Single-phase, 85 to 264 VAC, 90 to 350 VDC *12, 265 to 300 VAC (1 second)				
	Frequency *2	50/60 Hz (47 to 450 Hz)		50/60 Hz (47 to 63 Hz)		
	Input current	115 VAC input *1	1.1 A typ.		1.2 A typ.	
		230 VAC input *1	0.66 A typ.		0.63 A typ.	
	Power factor	230 VAC input, 100% load	---		0.9 min.	
	Leakage current *3	115 VAC input	0.5 mA max.			
		230 VAC input	1 mA max.			
	Inrush current *4 (for a cold start at 25°C)	115 VAC input	16 A typ.			
230 VAC input		32 A typ.				
Output	Rated output current	2.5 A		5 A		
	Rated output electric power	60 W		120 W		
	Maximum boost current	3 A		6 A		
	Voltage adjustment range *5	21.6 to 28 V (with V.ADJ)				
	Ripple & Noise voltage *6	100 to 240 VAC input, 100% load *1	190 mVp-p max. at 20 MHz of bandwidth		110 mVp-p max. at 20 MHz of bandwidth	
	Input variation influence *7	0.5% max.				
	Load variation influence *8	1.5% max.				
	Temperature variation influence	115 to 230 VAC input	0.05%/°C max.			
	Start up time *4	115 VAC input *1	800 ms typ.		400 ms typ.	
230 VAC input *1		600 ms typ.		300 ms typ.		
Hold time *6	115 VAC input *1	20 ms typ.		45 ms typ.		
	230 VAC input *1	90 ms typ.		45 ms typ.		
Additional functions	Overload protection	Yes, automatic reset				
	Overvoltage protection *9	Yes, 130% or higher of rated output voltage, power shut off (shut off the input voltage and turn on the input again)				
	Series operation	Yes (For up to two Power Supplies, external diodes are required.)				
	Parallel operation	Yes (For up to two Power Supplies), Refer to <i>Parallel Operation</i> on page 15 for details.				
	Output indicator	Yes (LED: Green)				
Insulation	Withstand voltage	3.0 kVAC for 1 min. (between all input terminals and output terminals), current cutoff 10 mA				
		2.0 kVAC for 1 min. (between all input terminals and PE terminals), current cutoff 10 mA				
		1.0 kVAC for 1 min. (between all output terminals and PE terminals), current cutoff 20 mA				
Insulation resistance	100 MΩ min. (between all output terminals and all input terminals/PE terminals) at 500 VDC					
Environment	Ambient operating temperature *10	-40 to 70°C (Derating is required according to the temperature. Refer to <i>Engineering Data</i>) (with no condensation or icing)				
	Storage temperature	-40 to 85°C (with no condensation or icing)				
	Ambient operating humidity	95% RH max. (Storage humidity: 95% RH max.)				
	Vibration resistance	10 to 55 Hz, maximum 5G, 0.42 mm half amplitude for 2 h each in X, Y, and Z directions				
	Shock resistance	150 m/s ² , 3 times each in ±X, ±Y, ±Z directions				
Reliability	MTBF	Refer to <i>Reference Value</i> on page 8				
	Life expectancy *11	10 years min.				
Construction	Weight	250 g max.		400 g max.		
	Cooling fan	No				
	Degree of protection	IP20 by EN/IEC 60529				
Standards	Harmonic current emissions	Conforms to EN 61000-3-2				
	EMI	Conducted Emissions	Conforms to EN 61204-3 Class B, EN 55011 Class B			
		Radiated Emissions	Conforms to EN 61204-3 Class B, EN 55011 Class B			
	EMS	Conforms to EN 61204-3 high severity levels				
	Approved Standards	UL Listing: UL 508, ANSI/ISA 12.12.01 (For 60 W only Class2 Output: Per UL 1310) cUL: CSA C22.2 No107.1, CSA C22.2 No213 (For 60 W only Class2 Output: Per CSA C22.2 No.223) UL UR: UL 60950-1 (Recognition) OVCII (≤ 3000 m) Pol2 cUR: CSA C22.2 No.60950-1 OVCII (≤ 3000 m) Pol2 EN: EN 50178 OVCIII (≤ 2000 m) OVCII (2000 m ≤ and ≤ 3000) Pol2, EN 60950-1 OVCII (≤ 3000 m) Pol2				
		Conformed Standards	PELV (EN/IEC 60204-1) *12 EN/IEC 61558-2-16 *12			
	Marine Standards *12	Lloyd's register DNV GL (Certification is pending for DNV GL.)				
	SEMI	Conforms to F47-0706 (200 to 240 VAC input)				

-
- *1. The value is when both rated output voltage and rated output current are satisfied.
 - *2. Do not use an inverter output for the product. Inverters with an output frequency of 50/60 Hz are available, but the rise in the internal temperature of the product may result in ignition or burning.
If the input is connected to a UPS, do not connect a UPS with a square-wave output.
Doing so will cause the internal temperature of the product to increase, possibly causing smoking or burning.
 - *3. The value for the leakage current is determined according to the Electrical Appliances and Material Safety Act.
 - *4. Refer to *Inrush Current, Startup Time, Output Hold Time* on page 8 for details.
 - *5. If the output voltage adjuster (V. ADJ) is turned, the voltage will increase by more than 28 V min of the voltage adjustment range. When adjusting the output voltage, confirm the actual output voltage from the product and be sure that the load is not damaged.
 - *6. A characteristic when the ambient operating temperature of 25°C.
 - *7. This is the maximum variation in the output voltage when the input voltage is gradually changed within the allowable input voltage range at the rated output voltage and rated output current.
 - *8. 100 to 240 VAC input, in the range of 0 A to the rated output current.
 - *9. Refer to *Overvoltage Protection* on page 8 for the time when input voltage shuts off and input turns on again.
 - *10. At -40 to -25°C, time will be required before the rated output voltage is output after the input voltage is input.
Also, the ripple noise value may exceed the value shown in the above table.
 - *11. Refer to *Recommended Replacement Periods and Periodic Replacement for Preventive Maintenance* on page 16 for details.
 - *12. Refer to *Standard Compliance*, below.

Standard Compliance

- EN/IEC 61558-2-16
The S8VK-S was designed based on EN/IEC 61558-2-16.
Currently, IEC 61558-2-17 has been replaced by IEC 61558-2-16.
When certification was received for EN/IEC 60204-1 (Machinery Safety), it was necessary to go through a control transformer to the control circuits. However, a control transformer is not always necessary for product that have been certified for the safety standard for OVCIII or for product that use a transformer that conforms to EN/IEC 61558-2-16.
- Safety Standards for a DC Input
The following safety standards are applicable for when a DC input is used: UL 60950-1, cUR (CSA C22.2 No. 60950-1), EN 50178, EN 60950-1, Lloyd's, and DNV-GL. (Certification is pending for DNV GL.)
Safety standard compliance is achievable by connecting a UL-certified fuse as specified below.
Select an external fuse that satisfies the following conditions:
S8VK-S06024: 350 VDC min., 6 A
S8VK-S12024: 350 VDC min., 8 A
- Conformance to Marine Standards
Noise filter "FN2080-10-06" manufactured by SCHAFFNER Corporation. or equivalent should be connected to the Input terminals of S8VK-S series.
End Plate (PFP-M) to both sides of the Power Supply to hold the Power Supply in place.
- To comply with PELV output requirements for EN/IEC 60204-1, ground the negative side of the output (-V) to a protective earth (PE).

S8VK-S

Connections

Block Diagrams

S8VK-S06024 (60 W)

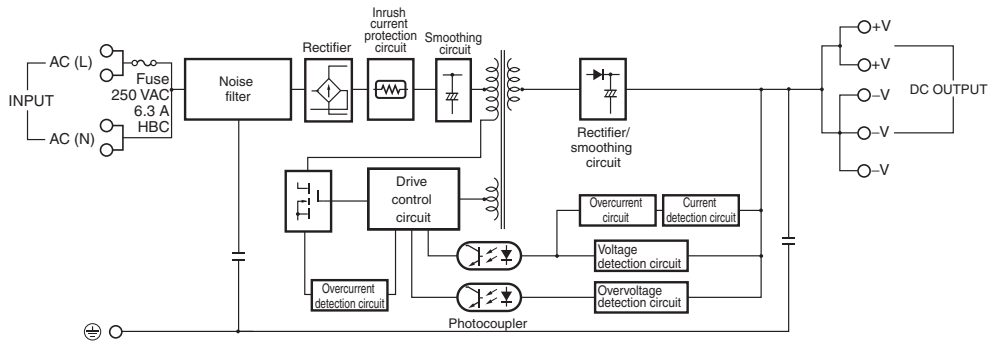

S8VK-S12024 (120 W)

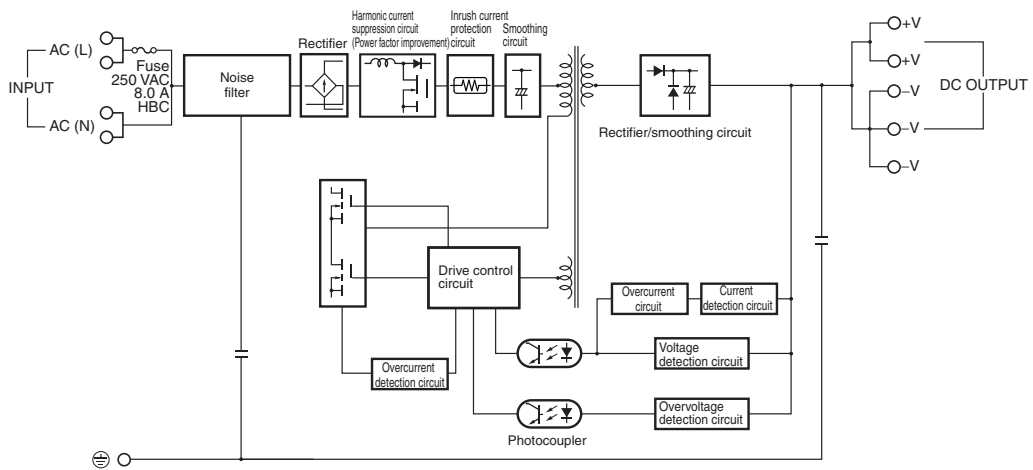

Construction and Nomenclature

Nomenclature

60-W Models

S8VK-S06024

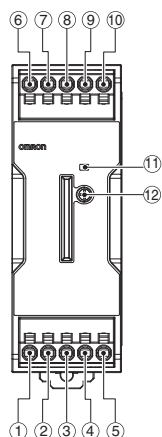

120-W Models

S8VK-S12024

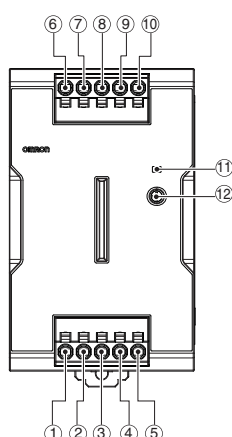

No.	Terminal name	Name	Function
1	L1	Input terminals	Connect the input lines to these terminals. *1
2	L2		
3	N1		
4	N2		
5	PE	Protective Earth terminal (PE)	Connect the ground line to this terminal. *2
6	+V1	DC Output terminals	Connect the load lines to these terminals.
7	+V2		
8	-V1		
9	-V2		
10	-V3		
11	---	Output indicator (DC ON: Green)	The green indicator indicates when a DC voltage is being output.
12	---	Output voltage adjuster (V.ADJ)	Use to adjust the voltage.

*1. The fuse is located on the (L) side. It is not user-replaceable. For a DC input, connect the positive voltage to the L terminal.

*2. This is the protective earth terminal specified in the safety standards. Always ground this terminal.

Derating Curve

60 W (S8VK-S06024)

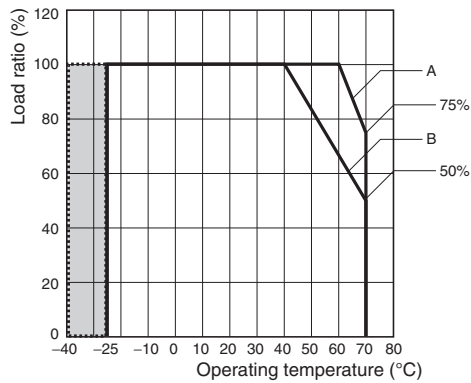

- Note:**
- At less than 90 VAC, derate the load at 2.5%/V.
 - For a DC input, reduce the load given in the above derating curve by multiplying by the following coefficients.
S8VK-S06024: 0.9
 - In the shaded area, time is required to reach the rated output voltage after the input voltage is applied. Also, the ripple noise value in this area may exceed the range given on page 2.

- A.** Standard mounting, mounted with Front-mounting Bracket, or mounted with Side-mounting Bracket
B. Face-up mounting

60 W (S8VK-S06024) Front, Side-by-side mounting

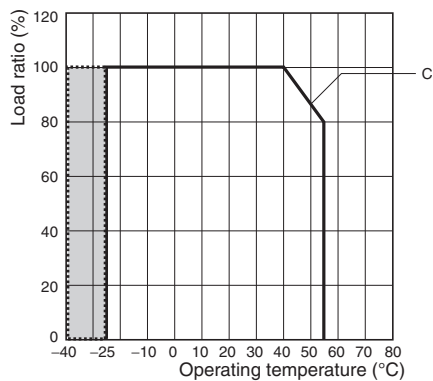

- Note:**
- Apply the rated voltage
 - In the shaded area, time is required to reach the rated output voltage after the input voltage is applied. Also, the ripple noise value in this area may exceed the range given on page 2.

- C.** Front, Side-by-side Mounting

120 W (S8VK-S12024)

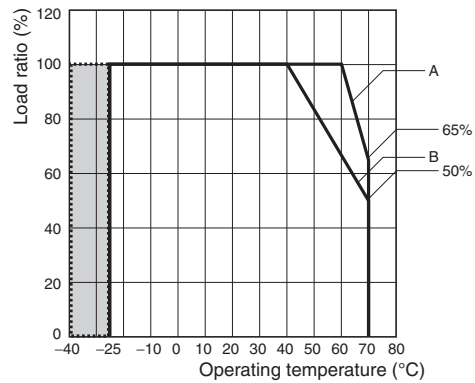

- Note:**
- At less than 90 VAC, derate the load at 2.5%/V.
 - For a DC input, reduce the load given in the above derating curve by multiplying by the following coefficients.
S8VK-S12024: 0.9
 - In the shaded area, time is required to reach the rated output voltage after the input voltage is applied. Also, the ripple noise value in this area may exceed the range given on page 2.

- A.** Standard mounting
B. Face-up mounting

120 W (S8VK-S12024) Front, Side-by-side mounting

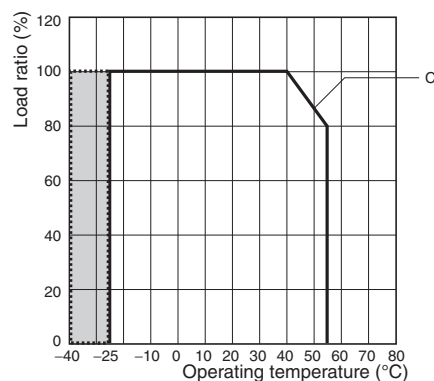

- Note:**
- Apply the rated voltage
 - In the shaded area, time is required to reach the rated output voltage after the input voltage is applied. Also, the ripple noise value in this area may exceed the range given on page 2.

- C.** Front, Side-by-side Mounting

This Power Supply can be used at an altitude of 3,000 m.
Between 2,000 and 3,000 m, derate the load according to the following derating curve.

60 W (S8VK-S06024)

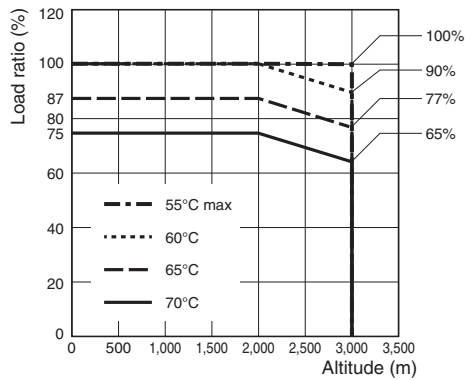

- Note: 1.** At less than 90 VAC, derate the load at 2.5%/V.
- Note: 2.** For a DC input, reduce the load given in the above derating curve by multiplying by the following coefficients.
S8VK-S06024: 0.9

Standard mounting, mounted with Front-mounting Bracket, or mounted with Side-mounting Bracket

60 W (S8VK-S06024) Front, Side-by-side mounting

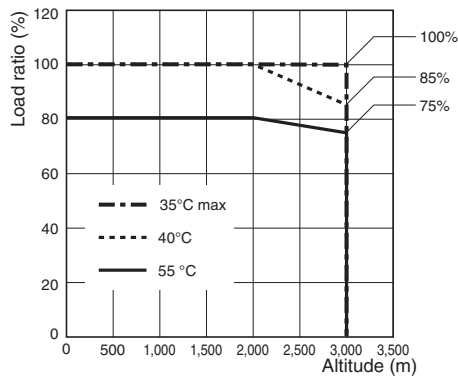

- Note: 1.** Apply the rated voltage
Front, Side-by-side mounting

120 W (S8VK-S12024)

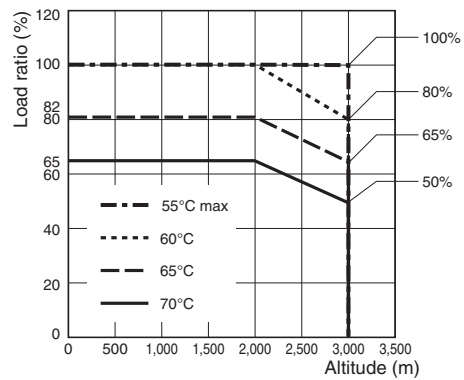

- Note: 1.** At less than 90 VAC, derate the load at 2.5%/V.
- Note: 2.** For a DC input, reduce the load given in the above derating curve by multiplying by the following coefficients.
S8VK-S12024: 0.9

Standard mounting

120 W (S8VK-S12024) Front, Side-by-side mounting

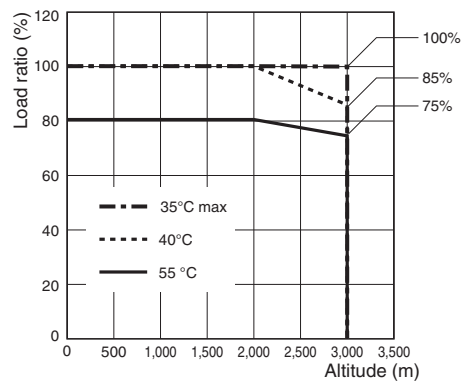

- Note: 1.** Apply the rated voltage
Front, Side-by-side mounting

Mounting

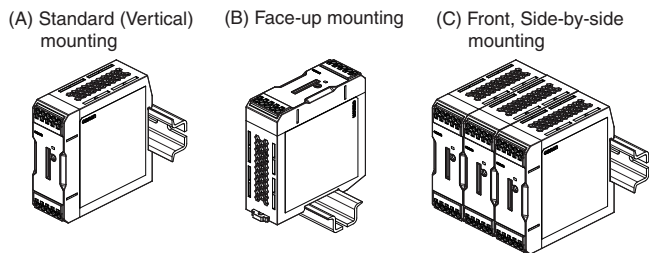

Overload Protection

The load and the power supply are automatically protected from overcurrent damage by this function. Overload protection is activated if the output current rises above 121% of the rated current. When the output current returns within the rated range, overload protection is automatically cleared.

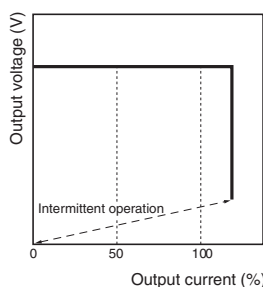

The values shown in the above diagrams are for reference only.

- Note:**
- Internal parts may occasionally deteriorate or be damaged if a short-circuited or overcurrent state continues during operation.
 - Internal parts may possibly deteriorate or be damaged if the Power Supply is used for applications with frequent inrush current or overloading at the load end. Do not use the Power Supply for such applications.

Overvoltage Protection

Consider the possibility of an overvoltage and design the system so that the load will not be subjected to an excessive voltage even if the feedback circuit in the product fails. If an excessive voltage that is approximately 130% of the rated voltage or more is output, the output voltage is shut OFF. Reset the input power by turning it OFF for at least three minutes and then turning it back ON again.

Note: Do not turn ON the power again until the cause of the overvoltage has been removed.

Inrush Current, Startup Time, Output Hold Time

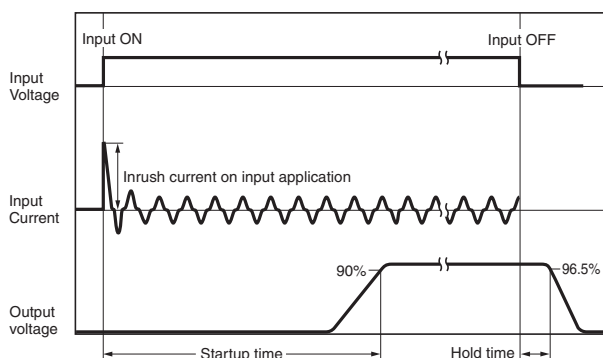

- Note:** Twice the normal inrush current will flow during parallel operation or for backup operation. Also, if crossover wiring is used for N number of Power Supplies, an inrush current of N times the inrush current for a standalone Power Supply will flow. Therefore, check the fusing characteristics of fuses and operating characteristics of breakers making sure that the external fuses will not burn out and the circuit breakers will not be activated by the inrush current.

Two phases application for Single phase models For All Single phase Models, S8VK-S

Basically OMRON single phase power supply can be used on two-phases of a 3-phase-system when some of conditions satisfy like below.

- The supplying voltage is below the maximum rated input. OMRON Power supply allows the input voltage equivalent or less than 240 VAC+10%. Please confirm the input voltage between two lines if the input voltage satisfies this condition before connecting.
- The external protector is needed on N input line to secure a safety. N line has no protection of a fuse internally. An appropriate fuse or circuit breaker should be connected on N input line like the following.

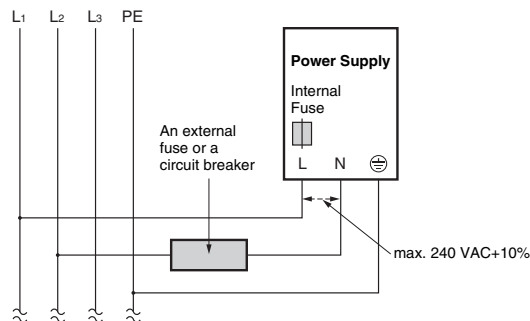

Reference Value

	Value
Reliability (MTBF)	Single phase model 60 W: 640,000 120 W: 480,000
Definition	MTBF stands for Mean Time Between Failures, which is calculated according to the probability of accidental device failures, and indicates reliability of devices. Therefore, it does not necessarily represent a life of the product.
Life expectancy	10 yrs. Min.
Definition	The life expectancy indicates average operating hours under the ambient temperature of 40°C and a load rate of 50%. Normally this is determined by the life expectancy of the built-in aluminum electrolytic capacitor.

Dimensions

S8VK-S06024 (60 W)

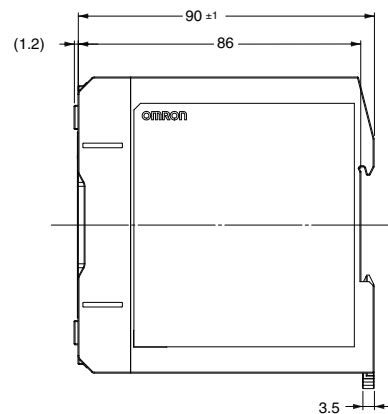
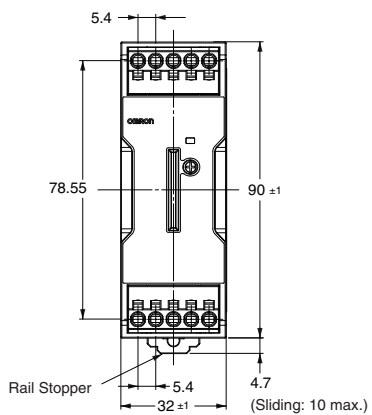

S8VK-S12024 (120 W)

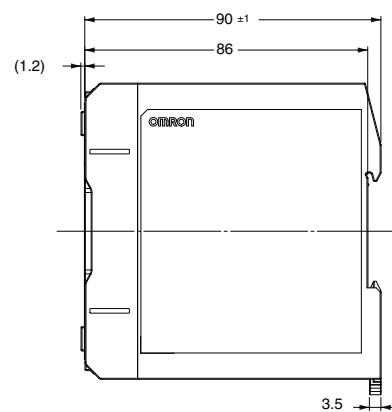
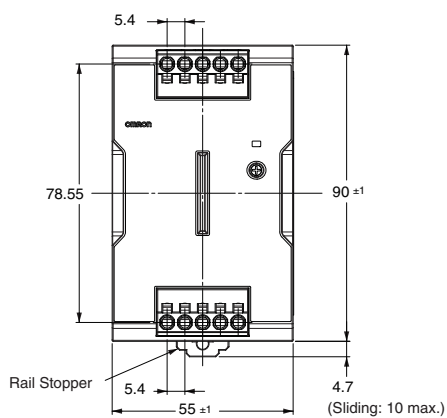

DIN Rail (Order Separately)

(Unit: mm)

Mounting Rail (Material: Aluminum)

PFP-100N
PFP-50N

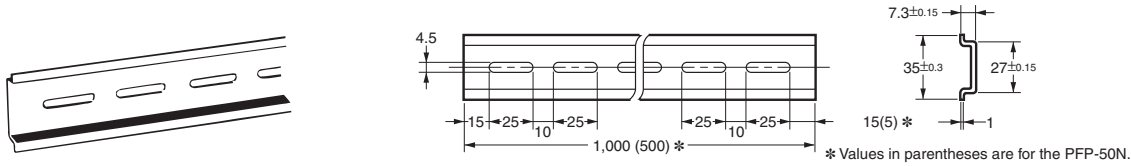

Mounting Rail (Material: Aluminum)

PFP-100N2

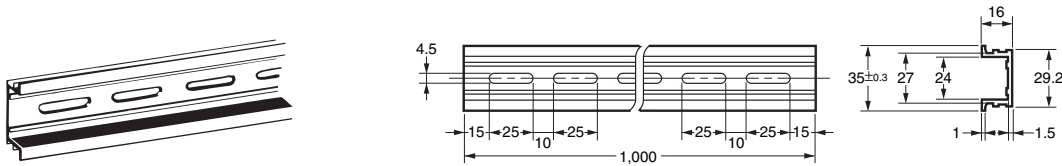

End Plate

PFP-M

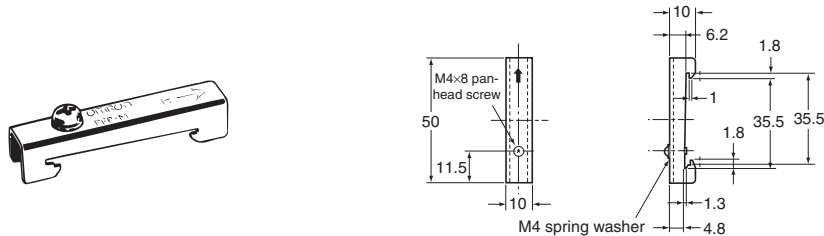

Note: If there is a possibility that the Unit will be subject to vibration or shock, use a steel DIN Rail. Otherwise, metallic filings may result from aluminum abrasion.

Mounting Brackets

Name	Model
Front-mounting bracket (for 60 W models)	S82Y-VS10F
Side-mounting bracket (for 60 W models)	S82Y-VS10S

Note: Be sure to use the accessory screws.

Mounting screw tightening torque (recommended): 4.43 to 5.31 lb-in (0.5 to 0.6 N·m)





Type	Model	Dimensions	Appearance
Front-mounting bracket (For 60 W models)	S82Y-VS10F	<p>Two locations Mounting screw tightening torque: 0.5 to 0.6 N·m</p>	
Side-mounting bracket (For 60 W models)	S82Y-VS10S	<p>Three locations Mounting screw tightening torque: 0.5 to 0.6 N·m</p>	<p>Left-side mounting Right-side mounting</p>

Safety Precautions

Warning Indications

 WARNING	Indicates a potentially hazardous situation which, if not avoided, will result in minor or moderate injury, or may result in serious injury or death. Additionally, there may be significant property damage.
 CAUTION	Indicates a potentially hazardous situation which, if not avoided, may result in minor or moderate injury or in property damage.
Precautions for Safe Use	Supplementary comments on what to do or avoid doing, to use the product safely.
Precautions for Correct Use	Supplementary comments on what to do or avoid doing, to prevent failure to operate, malfunction or undesirable effect on product performance.

Meaning of Product Safety Symbols

	Used to warn of the risk of electric shock under specific conditions.
	Used to warn of the risk of minor injury caused by high temperatures.
	Use to indicate prohibition when there is a risk of minor injury from electrical shock or other source if the product is disassembled.
	Used for general mandatory action precautions for which there is no specified symbol.

WARNING

Insert the solid wire or ferrule straight into the terminal block until the end touches the terminal block.



CAUTION

Minor electric shock, fire, or Product failure may occasionally occur. Do not disassemble, modify, or repair the Product or touch the interior of the Product.



Minor burns may occasionally occur. Do not touch the Product while power is being supplied or immediately after power is turned OFF.



Minor injury due to electric shock may occasionally occur. Do not touch the terminals while power is being supplied. Always close the terminal cover after wiring.



Minor electric shock, fire, or Product failure may occasionally occur. Do not allow any pieces of metal or conductors or any clippings or cuttings resulting from installation work to enter the Product.



Precautions for Safe Use

Installation Environment

- Do not use the Power Supply in locations subject to shocks or vibrations. In particular, install the Power Supply as far away as possible from contactors or other devices that are a vibration source. For usage onboard a ship, always attach an End Plate (PFP-M) to both sides of the Power Supply to hold the Power Supply in place.
- Install the Power Supply well away from any sources of strong, high-frequency noise and surge.

Operating Life

- The life of a Power Supply is determined by the life of the electrolytic capacitors used inside. Here, Arrhenius Law applies, i.e., the life will be cut in half for each rise of 10°C or the life will be doubled for each drop of 10°C. The life of the Power Supply can thus be increased by reducing its internal temperature.

Ambient Operating and Storage Environments

- Store the Power Supply at a temperature of • 40 to 85°C and a humidity of 95% or less.
- Do not use the Power Supply in areas outside the derating curve otherwise, internal parts may occasionally deteriorate or be damaged.
- Use the Power Supply at a humidity of 95% max.
- Do not use the Power Supply in locations subject to direct sunlight.
- Do not use the Power Supply in locations where liquids, foreign matter, or corrosive gases may enter the interior of Power Supply.

Mounting

- Take adequate measures to ensure proper heat dissipation to increase the long-term reliability of the Power Supply. Be sure to allow convection in the atmosphere around devices when mounting. Do not use in locations where the ambient temperature exceeds the range of the derating curve.
- When cutting out holes for mounting, make sure that cuttings do not enter the interior of the Power Supplies.

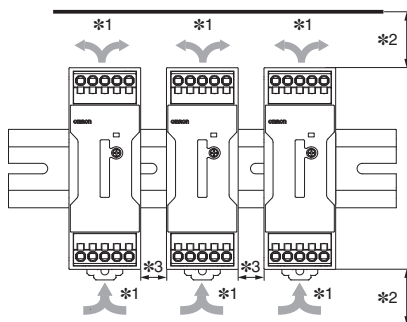

- *1. Convection of air
- *2. Vertical separation: 25 mm or more
- *3. Horizontal separation: 15mm or more

- S8VK-S Power Supplies can be mounted side-to-side. Use the Product within the derating curve for the front, side-by-side mounting.

DIN Rail Mounting

To mount the Block on a DIN Rail, hook portion (A) of the Block onto the rail and press the Block in direction (B).

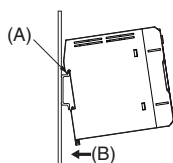

To dismount the Block, pull down portion (C) with a flat-blade screwdriver and pull out the Block.

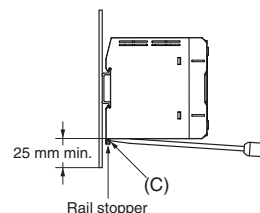

Wiring

- Connect the ground completely. A protective earthing terminal stipulated in safety standards is used. Electric shock or malfunction may occur if the ground is not connected completely.
- Minor fire may possibly occur. Ensure that input and output terminals are wired correctly.
- When you insert wires or insert a screwdriver into a release hole, do not press down on the terminal block with a force of 40 N or greater.
- Do not wire anything to the release holes.
- Do not tilt or twist a flat-blade screwdriver while it is inserted into a release hole on the terminal block. The terminal block may be damaged.
- Insert a flat-blade screwdriver into the release holes at an angle. The terminal block may be damaged if you insert the screwdriver straight in.
- Do not allow the flat-blade screwdriver to fall out while it is inserted into a release hole.
- Do not bend a wire past its natural bending radius or pull on it with excessive force. Doing so may cause the wire disconnection.
- Do not insert more than one wire into each terminal insertion hole.
- Do not pre-solder the ends of the wires. Doing so will inhibit proper connection.
- Be sure to remove the sheet covering the Product for machining before power-ON so that it does not interfere with heat dissipation.
- Use the following material for the wires to be connected to the S8VK-S to prevent smoking or ignition caused by abnormal loads.

Terminal name	Model	Recommended wire gauge	Solid/stranded wire
		AWG	
Input terminal	S8VK-S06024, S12024	AWG22 to 14	0.34 to 2.5 mm ²
DC output terminal	S8VK-S06024	AWG20 to 14	0.5 to 2.5 mm ²
	S8VK-S12024	AWG18 to 14	0.75 to 2.5 mm ²
PE (protective earth) terminal	S8VK-S06024, S12024	AWG14	2.0 to 2.5 mm ²

- Input crossover wiring can be used for the input side of this Power Supply.
- Do not use crossover wiring for more than five Power Supplies, and do not allow the steady-state current to the input terminals to exceed 5 A. The above table gives the recommended wires for one Power Supply.
- If you use crossover wiring for N number of Power Supplies, a current that is N times the current for a standalone Power Supply may flow to the input terminals. Take this into consideration when you select wiring materials.

Stripping length

Recommended Wire	Stripping length	
	Ferrules used	Ferrules not used
0.34 to 1.5mm ² /Equivalent to AWG22 to 16	10 mm	8 mm
2 to 2.5mm ² /Equivalent to AWG14	12 mm	10 mm

Note: Please use Ferrules with UL certification (R/C).

● Connecting wires to the Push-In Plus Terminal Block

Part Names of the Terminal Block

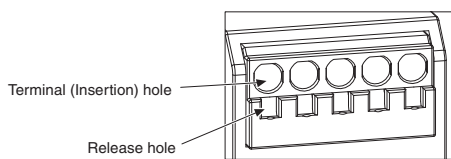

Connecting Wires with Ferrules and Solid Wires

Insert the solid wire or ferrule straight into the terminal block until the end touches the terminal block.

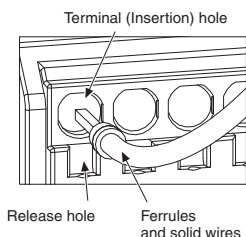

If a wire is difficult to connect because it is too thin, use a flat-blade screwdriver in the same way as when connecting stranded wire.

Connecting Stranded Wires

Use the following procedure to connect the wires to the terminal block.

1. Hold a flat-blade screwdriver at an angle and insert it into the release hole. The angle should be between 10° and 15°. If the flat-blade screwdriver is inserted correctly, you will feel the spring in the release hole.
2. With the flat-blade screwdriver still inserted into the release hole, insert the wire into the terminal hole until it strikes the terminal block.
3. Remove the flat-blade screwdriver from the release hole.

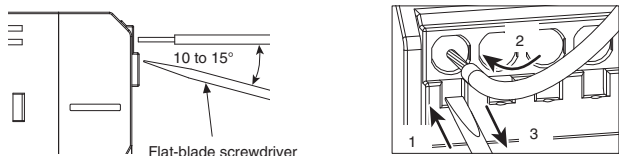

Checking Connections

- After the insertion, pull gently on the wire to make sure that it will not come off and the wire is securely fastened to the terminal block.
- To prevent short circuits, insert the stripped part of a stranded or solid wire or the conductor part of a ferrule until it is hidden inside the terminal insertion hole. (See the following diagram.)

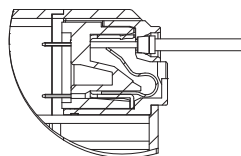

● Removing wires from the Push-In Plus Terminal Block

Use the following procedure to remove wires from the terminal block. The same method is used to remove stranded wires, solid wires, and ferrules.

1. Hold a flat-blade screwdriver at an angle and insert it into the release hole.
2. With the flat-blade screwdriver still inserted into the release hole, remove the wire from the terminal insertion hole.
3. Remove the flat-blade screwdriver from the release hole.

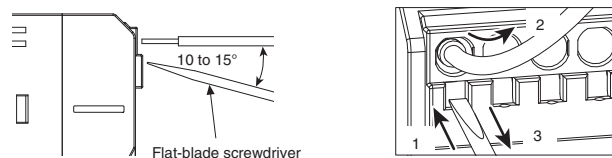

● Recommended Ferrules and Crimping Tools

Recommended ferrules

Applicable wire		Ferrule Conduct or length (mm)	Recommended ferrules		
(mm ²)	(AWG)		Manufactured by Phoenix Contact	Manufactured by Weidmuller	Manufactured by Wago
0.34	22	8	AI0.34-8	H0.34/12	FE-0.34-8N-TQ
0.5	20	8	AI0.5-8	H0.5/14	FE-0.5-8N-WH
0.75	18	8	AI0.75-8	H0.75/14	FE-0.75-8N-GY
1	18	8	AI1-8	H1.0/14	FE-1.0-8N-RD
1.5	16	8	AI1.5-8	H1.5/14	FE-1.5-8N-BK
2.5	14	10	AI2.5-10	H2.5/16DS	FE-2.5-10N-BU
Recommended crimp tool			CRIMPFOX6 CRIMPFOX6-F CRIMPFOX10S	PZ6 roto	Variocrimp4

Note: 1. Make sure that the outer diameter of the wire is smaller than the inner diameter of the insulating sleeve of the recommended ferrule.

2. Make sure that the ferrule processing dimensions conform to the following figure.

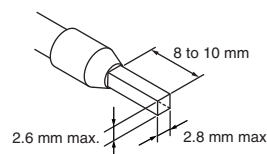

Recommended Flat-blade Screwdriver

Use a flat-blade screwdriver to connect and remove wires. Use the following flat-blade screwdriver.

The following table shows manufacturers and models as of 2015/Dec.

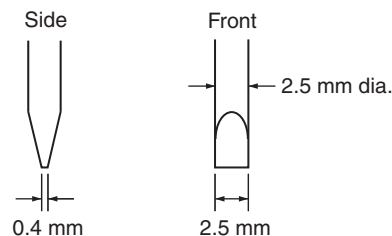

Model	Manufacturer
XW4Z-00B	Omron
ESD0.40X2.5	Wera
SZF 0.4X2.5	Phoenix Contact
0.4X2.5X75 302	Wiha
AEF.2.5X75	Facom
210-719	Wago ^{*1}
SDI 0.4X2.5X75	Weidmuller ^{*1}
98 20 25	KNIPPEX ^{*1}

^{*1}. Insulated types of Flat-blade Screw driver, strongly recommended to prevent from an electric shock.

Power Boost Function

The boost current is a temporary current that exceeds the rated current.

However, it should meet the following four boost current conditions.

1. Time that the boost current flows: $t_1 \leq 10$ s
2. The boost current: $I_p \leq$ Maximum boost current
3. The average output current: $I_{ave} \leq$ Rated output current
4. The time ratio of the boost current flow: Duty $\leq 30\%$

$$\text{Duty} = \frac{t_1}{t_1 + t_2} \times 100 [\%] \leq 30\%$$

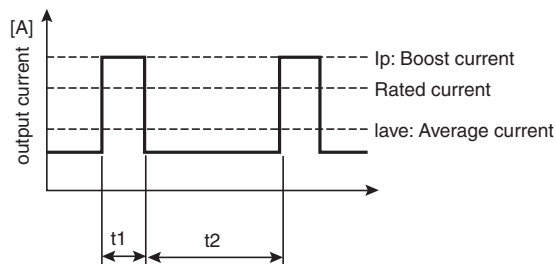

- Do not allow a boost current to flow for more than 10 s. Do not allow the duty to exceed 30%. These conditions may damage the Power Supply.
- Do not allow the average current for one cycle of the boost current to exceed the rated current. The Power Supply may be damaged.
- Derate the load at the boost current according to the ambient operating temperature and mounting direction.

Overcurrent Protection

- Internal parts may possibly deteriorate or be damaged if a short-circuited or overcurrent state continues during operation.
- Internal parts may possibly deteriorate or be damaged if the Power Supply is used for applications with frequent inrush current or overloading at the load end. Do not use the Power Supply for such applications.

Charging a Battery

If you connect a battery as the load, install overcurrent control and overvoltage protection circuits.

Output Voltage Adjuster (V.ADJ)

- The output voltage adjuster (V.ADJ) may possibly be damaged if it is turned with unnecessary force. Do not turn the adjuster with excessive force.
- After completing output voltage adjustment, be sure that the output power or output current does not exceed the rated output electric power or rated output current.

Series Operation

Two Power Supplies can be connected in series.

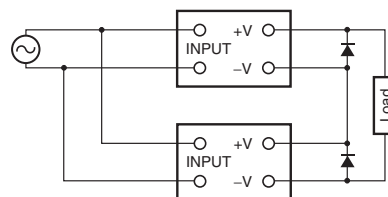

Note 1. The diode is connected as shown in the figure. If the load is short-circuited, a reverse voltage will be generated inside the product. If this occurs the product may possibly deteriorate or be damaged. Always connect a diode as shown in the figure.

Select a diode having the following ratings.

Type	Schottky Barrier diode
Dielectric strength (VRRM)	Twice the output voltage or above
Forward current (IF)	Twice the rated output current or above

2. Although Products having different specifications can be connected in series, the current flowing through the load must not exceed the smaller rated output current.

Making Positive/Negative Outputs

- The outputs are floating outputs (i.e., the primary circuits and secondary circuits are separated). You can therefore make positive and negative outputs by using two Power Supplies. You can make positive and negative outputs with any of the models.

If positive and negative outputs are used, connect Power Supplies of the same model as in the following figure. (Combinations with different output capacities or output voltages can be made. However, use the lower of the two maximum rated output currents as the current to the loads.)

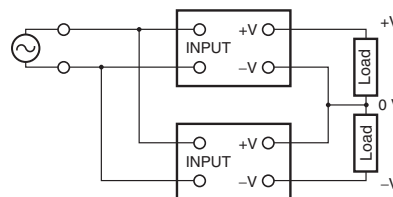

- Depending on the model, internal circuits may be damaged due to startup failure when the power is turned ON if loads such as a servomotor or operational amplifier may operate in series. Therefore, connect bypass diodes (D1, D2) as shown in the following figure.

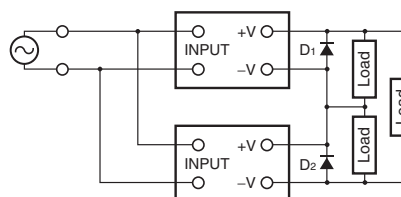

- Use the following information as a guide to the diode type, dielectric strength, and current.

Type	Schottky Barrier diode
Dielectric strength (VRRM)	Twice the output voltage or above
Forward current (IF)	Twice the rated output current or above

Parallel Operation

Parallel operation is used when the output current from one Power Supply is insufficient for the load. Power Supplies are connected in parallel to increase the output current.

Two Power Supplies can be connected in parallel.

1. You must meet the following conditions to use parallel operation.
 - Standard mounting.
 - The range of ambient temperature is -25 to 40°C.
Left and right interval 15 mm or more, Up and down interval 25 mm min.
 - Rated input voltage range and output voltage of 25 V max.
2. <S8VK-S06024 Only>
The total output current must be 4 A max.
3. Adjust the output voltage difference of each Power Supply to 50 mV or less, using the output voltage adjuster (V. ADJ).
4. There is no current balancing function for S8VK-G. A high output voltage unit may work at overcurrent state and in this situation, a life of a Power Supply will be extremely short.
After adjusting the output voltage, confirm the output current of the Power Supplies balances.
5. Using the parallel operation will not satisfy UL1310 Class2 output.
6. For Parallel Operation, to balance the current of the each unit, the length and thickness of each wire connected to the load and each unit must be same as much as possible.
7. If you use the output voltage may drop by several volts if the load changes rapidly (e.g., if the load starts or is disconnected). Use the S8VK-R or connect external diodes as shown in the figure.
For parallel operation with 60-W or 120-W Power Supplies, use the S8VK-R10.
8. Do not use parallel operation when there is the possibility that the input voltage will vary outside of the rated input range.



- Use the following information as a guide to the diode type, dielectric strength, and current.

Type	Schottky Barrier diode
Dielectric strength (VRRM)	Twice the output voltage or above
Forward current (IF)	Twice the rated output current or above

Backup Operation

Backup operation is possible if you use two Power Supplies of the same model.

Even if one Power Supplies fails, operation can be continued with the other Power Supply.

Make sure that the maximum load does not exceed the capacity of one Power Supply.

Use the S8VK-R or connect external diodes. For backup operation with 60-W or 120-W Power Supplies, use the S8VK-R10.

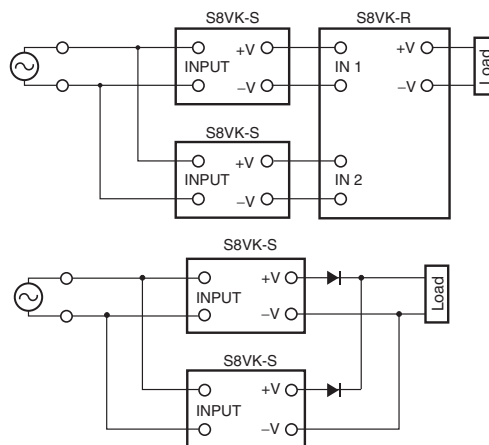

- Use the following information as a guide to the diode type, dielectric strength, and current.

Type	Schottky Barrier diode
Dielectric strength (VRRM)	Twice the output voltage or above
Forward current (IF)	Twice the rated output current or above

In Case There Is No Output Voltage

The possible cause for no output voltage may be that the overcurrent or overvoltage protection has operated. The internal protection may operate if a large amount of surge voltage such as a lightning surge occurs while turning ON the power supply.

In case there is no output voltage, please check the following points before contacting us:

- Checking overload protected status:
 - Check whether the load is in overload status or is short-circuited.
Remove wires to load when checking.
- Checking overvoltage or internal protection:
 - Turn the power supply OFF once, and leave it OFF for at least 3 minutes. Then turn it ON again to see if this clears the condition.

Audible Noise at Power ON

<S8VK-S12024 only>

A harmonic current suppression circuit is built into the Power Supply. This circuit can create noise when the input is turned ON, but it will last only until the internal circuits stabilize and does not indicate any problem in the Product.

Recommended Replacement Periods and Periodic Replacement for Preventive Maintenance

The recommended replacement period for preventive maintenance is greatly influenced by the application environment of the Power Supply. As a guideline, the recommended replacement period is 7 to 10 years.*

To prevent failures or accidents that can be caused by using a Power Supply beyond its service life, we recommend that you replace the Power Supply as early as possible within the recommended replacement period.

However, bear in mind that the recommended replacement period is for reference only and does not guarantee the life of the Power Supply.

Many electronic components are used in the Power Supply and the Power Supply depends on the correct operation of these components to achieve the original Power Supply functions and performance.

However, the influence of the ambient temperature on aluminum electrolytic capacitors is large, and the service life is reduced by half for each 10°C rise in temperature (Arrhenius law).

When the capacity reduction life of the electrolytic capacitor is reached, the Power Supply failures or accidents may occur.

We therefore recommend that you replace the Power Supply periodically to minimize product failures or accidents in advance.

* The recommended replacement period applies under the following conditions: rated input voltage, load rate of 50% max., ambient temperature of 40°C max., and the standard mounting method.

This product model is designed with a service life of 10 years minimum under the above conditions.

Terms and Conditions Agreement

Read and understand this catalog.

Please read and understand this catalog before purchasing the products. Please consult your OMRON representative if you have any questions or comments.

Warranties.

(a) Exclusive Warranty. Omron's exclusive warranty is that the Products will be free from defects in materials and workmanship for a period of twelve months from the date of sale by Omron (or such other period expressed in writing by Omron). Omron disclaims all other warranties, express or implied.

(b) Limitations. OMRON MAKES NO WARRANTY OR REPRESENTATION, EXPRESS OR IMPLIED, ABOUT NON-INFRINGEMENT, MERCHANTABILITY OR FITNESS FOR A PARTICULAR PURPOSE OF THE PRODUCTS. BUYER ACKNOWLEDGES THAT IT ALONE HAS DETERMINED THAT THE PRODUCTS WILL SUITABLY MEET THE REQUIREMENTS OF THEIR INTENDED USE.

Omron further disclaims all warranties and responsibility of any type for claims or expenses based on infringement by the Products or otherwise of any intellectual property right. (c) Buyer Remedy. Omron's sole obligation hereunder shall be, at Omron's election, to (i) replace (in the form originally shipped with Buyer responsible for labor charges for removal or replacement thereof) the non-complying Product, (ii) repair the non-complying Product, or (iii) repay or credit Buyer an amount equal to the purchase price of the non-complying Product; provided that in no event shall Omron be responsible for warranty, repair, indemnity or any other claims or expenses regarding the Products unless Omron's analysis confirms that the Products were properly handled, stored, installed and maintained and not subject to contamination, abuse, misuse or inappropriate modification. Return of any Products by Buyer must be approved in writing by Omron before shipment. Omron Companies shall not be liable for the suitability or unsuitability or the results from the use of Products in combination with any electrical or electronic components, circuits, system assemblies or any other materials or substances or environments. Any advice, recommendations or information given orally or in writing, are not to be construed as an amendment or addition to the above warranty.

See <http://www.omron.com/global/> or contact your Omron representative for published information.

Limitation on Liability; Etc.

OMRON COMPANIES SHALL NOT BE LIABLE FOR SPECIAL, INDIRECT, INCIDENTAL, OR CONSEQUENTIAL DAMAGES, LOSS OF PROFITS OR PRODUCTION OR COMMERCIAL LOSS IN ANY WAY CONNECTED WITH THE PRODUCTS, WHETHER SUCH CLAIM IS BASED IN CONTRACT, WARRANTY, NEGLIGENCE OR STRICT LIABILITY.

Further, in no event shall liability of Omron Companies exceed the individual price of the Product on which liability is asserted.

Suitability of Use.

Omron Companies shall not be responsible for conformity with any standards, codes or regulations which apply to the combination of the Product in the Buyer's application or use of the Product. At Buyer's request, Omron will provide applicable third party certification documents identifying ratings and limitations of use which apply to the Product. This information by itself is not sufficient for a complete determination of the suitability of the Product in combination with the end product, machine, system, or other application or use. Buyer shall be solely responsible for determining appropriateness of the particular Product with respect to Buyer's application, product or system. Buyer shall take application responsibility in all cases.

NEVER USE THE PRODUCT FOR AN APPLICATION INVOLVING SERIOUS RISK TO LIFE OR PROPERTY OR IN LARGE QUANTITIES WITHOUT ENSURING THAT THE SYSTEM AS A WHOLE HAS BEEN DESIGNED TO ADDRESS THE RISKS, AND THAT THE OMRON PRODUCT(S) IS PROPERLY RATED AND INSTALLED FOR THE INTENDED USE WITHIN THE OVERALL EQUIPMENT OR SYSTEM.

Programmable Products.

Omron Companies shall not be responsible for the user's programming of a programmable Product, or any consequence thereof.

Performance Data.

Data presented in Omron Company websites, catalogs and other materials is provided as a guide for the user in determining suitability and does not constitute a warranty. It may represent the result of Omron's test conditions, and the user must correlate it to actual application requirements. Actual performance is subject to the Omron's Warranty and Limitations of Liability.

Change in Specifications.

Product specifications and accessories may be changed at any time based on improvements and other reasons. It is our practice to change part numbers when published ratings or features are changed, or when significant construction changes are made. However, some specifications of the Product may be changed without any notice. When in doubt, special part numbers may be assigned to fix or establish key specifications for your application. Please consult with your Omron's representative at any time to confirm actual specifications of purchased Product.

Errors and Omissions.

Information presented by Omron Companies has been checked and is believed to be accurate; however, no responsibility is assumed for clerical, typographical or proofreading errors or omissions.

OMRON Corporation Industrial Automation Company
Kyoto, JAPAN

Contact: www.ia.omron.com

Regional Headquarters

OMRON EUROPE B.V.

Wegalaan 67-69, 2132 JD Hoofddorp
The Netherlands
Tel: (31)2356-81-300/Fax: (31)2356-81-388

OMRON ELECTRONICS LLC

2895 Greenspoint Parkway, Suite 200
Hoffman Estates, IL 60169 U.S.A.
Tel: (1) 847-843-7900/Fax: (1) 847-843-7787

OMRON ASIA PACIFIC PTE. LTD.

No. 438A Alexandra Road # 05-05/08 (Lobby 2),
Alexandra Technopark,
Singapore 119967
Tel: (65) 6835-3011/Fax: (65) 6835-2711

OMRON (CHINA) CO., LTD.

Room 2211, Bank of China Tower,
200 Yin Cheng Zhong Road,
PuDong New Area, Shanghai, 200120, China
Tel: (86) 21-5037-2222/Fax: (86) 21-5037-2200

Authorized Distributor:

© OMRON Corporation 2016 All Rights Reserved.
In the interest of product improvement,
specifications are subject to change without notice.

Cat. No. T205-E1-01-X

0416 (0416)